

### FDN/FRBU Port Opening Tool Kit

#### Technical Description

The FDN/FRBU Port Opening Tool Kit provides a safe, quick and easy use solution for opening the round ports on the 16/59 Port FDN and FRBU 16/13 Port Dome Closures.

The port opening tool kit is supplied with a single handle and 5 cutter assemblies for opening S/B, SD, RD, BD and ST ports (see base diagrams for port identification).

The cutter assemblies are replaceable parts which can be purchased separately once the original assemblies have reached the end of their life.

#### Features & Benefits

- Single Handle manages a range of cutter assemblies
- Quick and simple assembly changeover
- Smooth consistent cutting action
- Supplied with B/S, SD, RD, BD and ST Cutter Assemblies
- Replacement cutter assemblies available separately

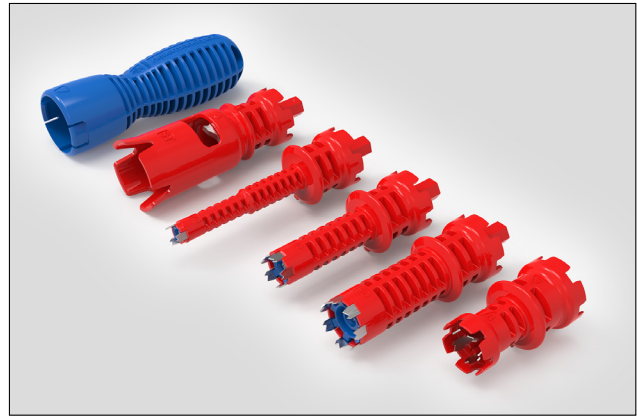

Port Opening Tool Sizes B/S, SD, RD, BD and ST



B/S cutter assembly.

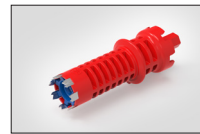

SD cutter assembly.

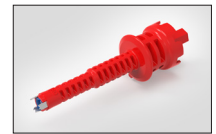

RD cutter assembly.

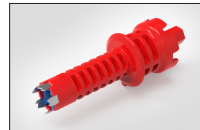

BD cutter assembly.



ST cutter assembly.

#### Technical Data

UNS No.	Part Code	Description	MOQ	Kit Content	
857-41119	PO-KIT-33060	Port Opening Tool Sizes B/S, SD, RD, BD and ST	1	Port Opening Tool Handle	1
				Cutter Assembly B & S Port	1
				Cutter Assembly SD Port	1
				Cutter Assembly RD Port	1
				Cutter Assembly BD Port	1
				Cutter Assembly ST Port	1
857-40930	PO-CA-KIT-33040	B & S Port Replacement Cutter Assembly	1	Cutter Assembly B & S Port	1
857-41122	PO-CA-KIT-33066	SD Port Replacement Cutter Assembly	1	Cutter Assembly SD Port	1
857-41123	PO-CA-KIT-33064	RD Port Replacement Cutter Assembly	1	Cutter Assembly RD Port	1
857-41124	PO-CA-KIT-33065	BD Port Replacement Cutter Assembly	1	Cutter Assembly BD Port	1
857-41125	PO-CA-KIT-33067	ST Port Replacement Cutter Assembly	1	Cutter Assembly ST Port	1

Dimensions (mm)	Height	Width	Depth
PO-CA-KIT-33040	36.5	36.5	67
PO-CA-KIT-33066	37	37	114
PO-CA-KIT-33064	36.5	36.5	137
PO-CA-KIT-33065	37	37	114
PO-CA-KIT-33067	42	42	120
Port Opening Tool Handle	44	44	135

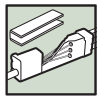

#### Technical Diagrams

Port Opening Tool Handle

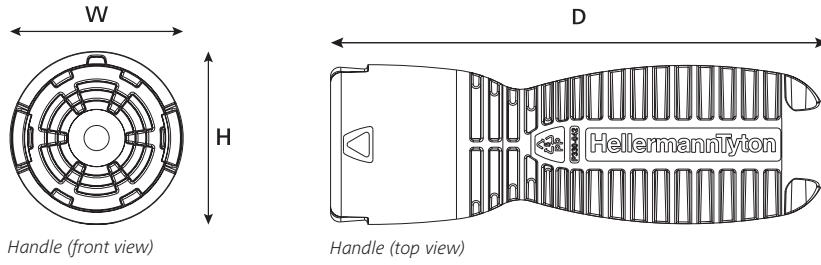

Handle (front view)

Handle (top view)

PO-KIT-33060

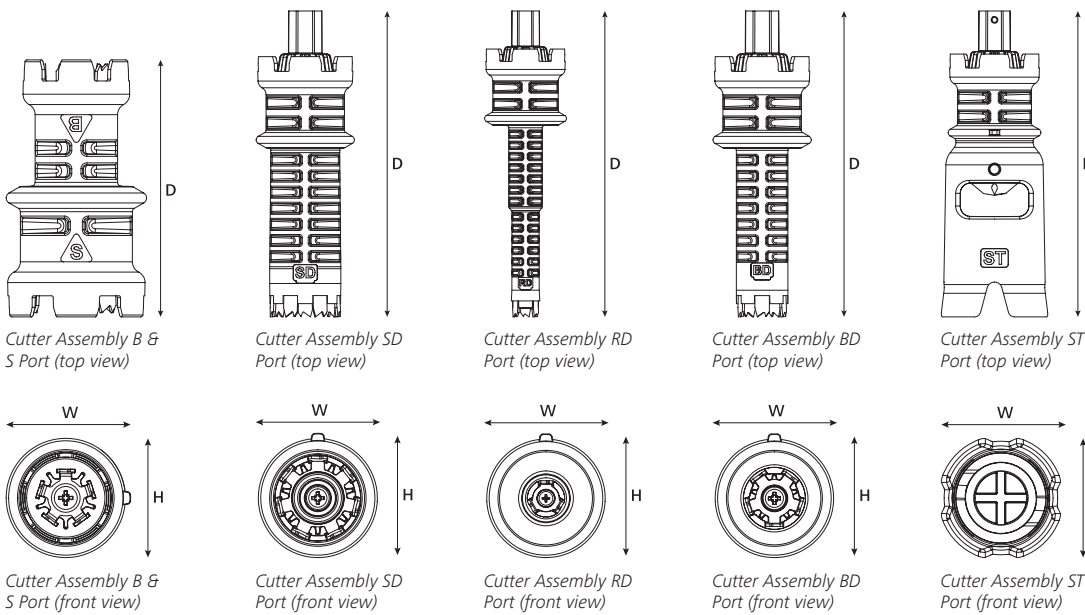

Cutter Assembly B & S Port (top view)

Cutter Assembly SD Port (top view)

Cutter Assembly RD Port (top view)

Cutter Assembly BD Port (top view)

Cutter Assembly ST Port (top view)

Cutter Assembly B & S Port (front view)

Cutter Assembly SD Port (front view)

Cutter Assembly RD Port (front view)

Cutter Assembly BD Port (front view)

Cutter Assembly ST Port (front view)

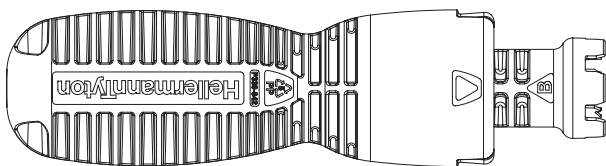

Port Opening Tool Handle and Cutter Assembly

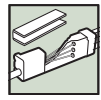

## Base Compatibility

